

# KOBELCO WELDING TODAY

*JULY 1998*  
*Vol.1 (No.3)*





# MX-100T

(AWS A5.20 E71T-1, E71T-1M)



**MX-100T: one of the most significant innovations in welding consumables for sheet metals. No more burn-through with a wide tolerance of welding currents and speeds.**

## Basic Characteristics of MX-100T

The metal-type flux cored wire, MX-100T, is an excellent choice for all-position welding of mild steel and 490N/mm<sup>2</sup> high tensile steel with thin sections. MX-100T uses either CO<sub>2</sub> gas or Ar+CO<sub>2</sub> gas mixtures for shielding. MX-100T, therefore, is classified as both E71T-1 and E71T-1M. "M" designates this electrode as using "Mixed Gases."

## More Resistant to Burn-Through

Burn-through, which results in a discontinuity in weldment, is caused when the current is too high and welding speed too slow. In burn-through, a molten metal drops to the opposite side of the groove through the root of the welding joint. Burn-through is a common problem in sheet metal welding. To solve this problem, smaller-sized wire is used with lower welding currents and higher welding speeds. However, higher welding speeds tend to cause an irregular weld profile.

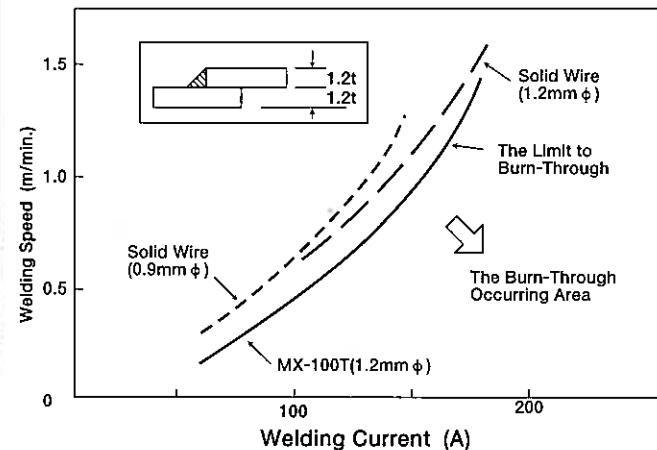

Fig. 1 - A Comparison between Ordinary Solid Wires and MX-100T on Burn-Through Resistance

Fig. 1 shows a comparison between ordinary solid wires and MX-100T on burn-through resistance, with the current and speed tolerances needed to prevent the burn-through. In this figure, it is obvious that MX-100T can tolerate higher welding currents than ordinary solid wires do, when thickness of the base metal and welding speed are constant.

## Wider Toleration of Welding Currents

MX-100T offers unsurpassed arc stability at the lower welding currents (50 - 150A) needed for welding sheet metals (0.8 - 3.2-mm-thick) by using the short-circuiting droplet transfer mode. However, MX-100T can also use higher welding currents: in fact, it can cover a wide range of welding currents as shown in Fig. 2.

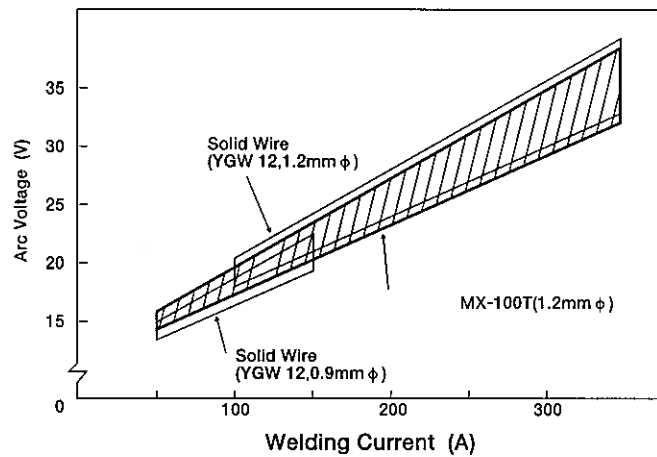

Fig.2 - A Comparison between Ordinary Solid Wires and MX-100T on Proper Welding Current and Voltage Range

## Superior Bead Profiles

MX-100T offers smooth, regular bead profiles without undercuts and overlaps in all-position welding. Figs. 3 and 4 show examples of such superior bead profiles. These figures show smooth fusion to the surfaces and the roots of the joints.

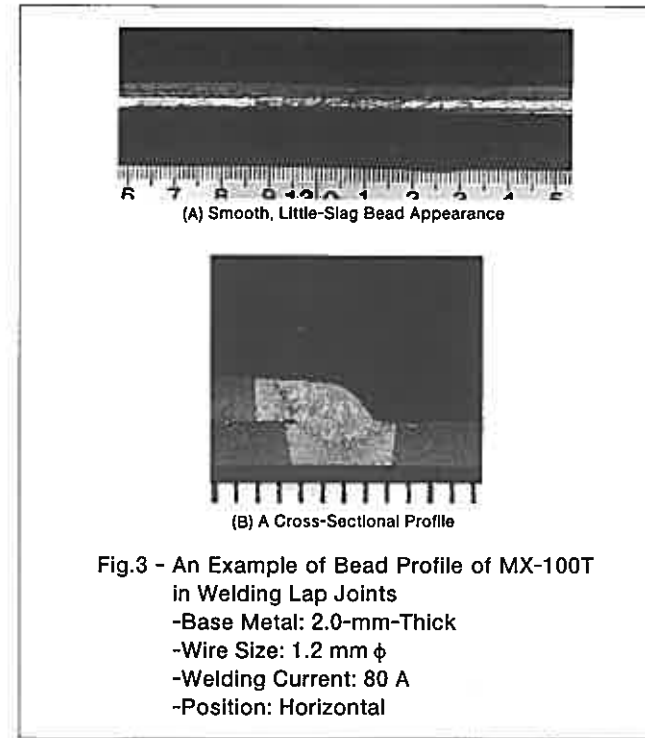

Fig.3 - An Example of Bead Profile of MX-100T in Welding Lap Joints  
-Base Metal: 2.0-mm-Thick  
-Wire Size: 1.2 mm φ  
-Welding Current: 80 A  
-Position: Horizontal

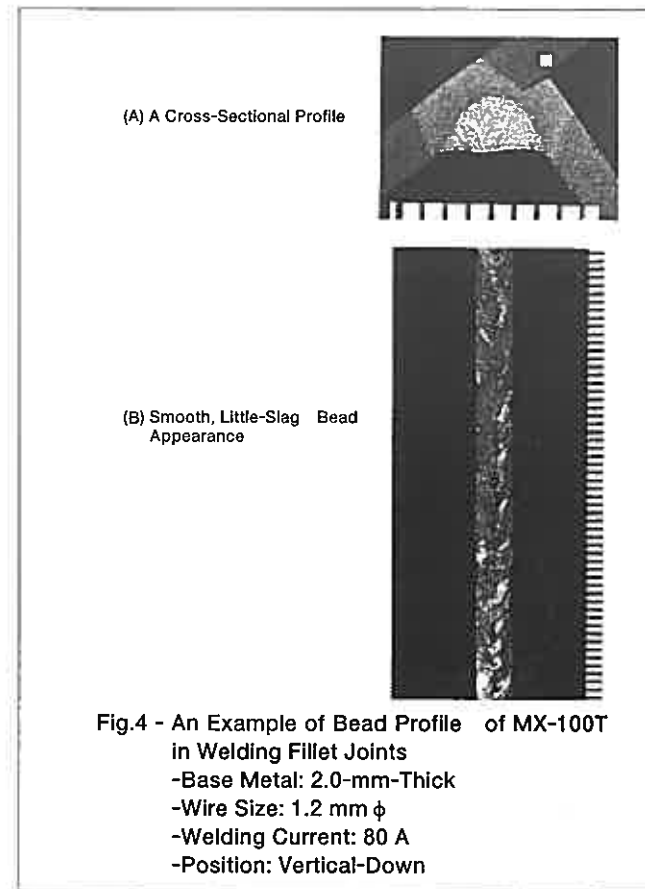

Fig.4 - An Example of Bead Profile of MX-100T in Welding Fillet Joints  
-Base Metal: 2.0-mm-Thick  
-Wire Size: 1.2 mm φ  
-Welding Current: 80 A  
-Position: Vertical-Down

## Where MX-100T Is Used

With mild steel and 490N/mm<sup>2</sup> high tensile steel as the base metal, the potential applications for MX-100T are almost limitless. However, MX-100T really shines in welding sheet metals using lower welding currents in

the short-circuiting droplet transfer mode. Sheet metals are often used in the auto, rolling stock, and electrical appliance industries. Table 1 shows typical welding procedures with MX-100T for the square groove joints of sheet metals.

Table 1 - Typical Welding Procedures for Square Groove Joints

| Plate Thickness (mm) | Root Opening (mm) | Welding Current (Amp) | Arc Voltage (Volt) | Welding Speed (cm/min) |
|----------------------|-------------------|-----------------------|--------------------|------------------------|
| 0.8                  | 0                 | 65                    | 14.5               | 100                    |
| 1.0                  | 0                 | 80                    | 14.5               | 90                     |
| 1.2                  | 0                 | 100                   | 15                 | 85                     |
| 1.6                  | 0                 | 120                   | 16                 | 75                     |
| 2.0                  | 1.0               | 135                   | 16                 | 75                     |
| 2.3                  | 1.3               | 135                   | 16                 | 75                     |
| 3.2                  | 1.5               | 140                   | 16                 | 30                     |

- Notes:  
 (1) Contact tip stand-off distance: 15mm  
 (2) Torch push-angle for forehand welding: 10 deg.  
 (3) No copper backing is used  
 (4) Joint design:

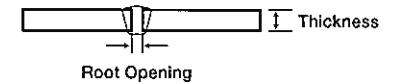

In addition to sheet metals, MX-100T provides a superior weld profile in the one-side root pass welding of horizontally fixed pipes. Fig. 5 shows an example of joint preparation and bead appearance on the reverse side of the groove.

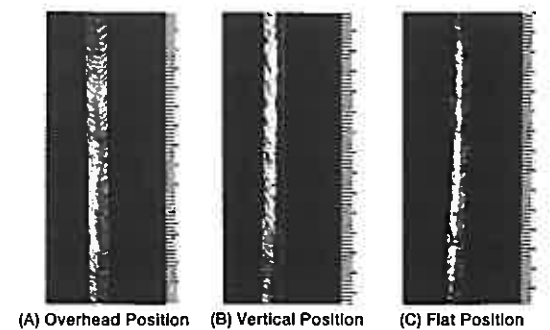
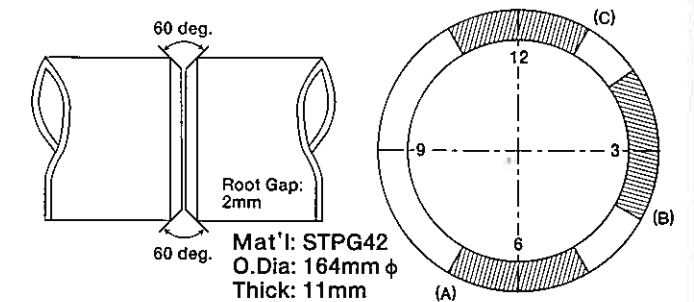

Fig.5 - MX-100T Bead Appearance on the Reverse Side of the Groove in the One-Side Root Pass Welding of Horizontally Fixed Pipes (Semi-Automatic, 1.2 mm φ Wire, 90 Amp.)

# LB-52-18

(AWS A5.1 E7018)

LB-52-18 is a low-hydrogen electrode with a high deposition rate for mild steel and 490N/mm<sup>2</sup> high tensile steel. It is an excellent choice for a variety of applications.

## Inception of LB-52-18

LB-52-18 was developed around 1962. "L" stands for low hydrogen, while "B" symbolizes a slag-shielding covered electrode. "52" refers to the typical tensile strength of deposited metal at the time the electrode was developed. "1" shows that it can be used in all positions, while "8" is the designation for "iron powder, low hydrogen" as in the AWS E7018 specification.

## High Deposition Rate

The deposition rate is the weight of metal deposited per unit of time. Typical deposition rates of LB-52-18 and an ordinary E7016 electrode, as a function of welding current, are shown in Fig. 1. It is clear that the deposition rates are dependent on welding current, and LB-52-18 provides approximately 20% higher

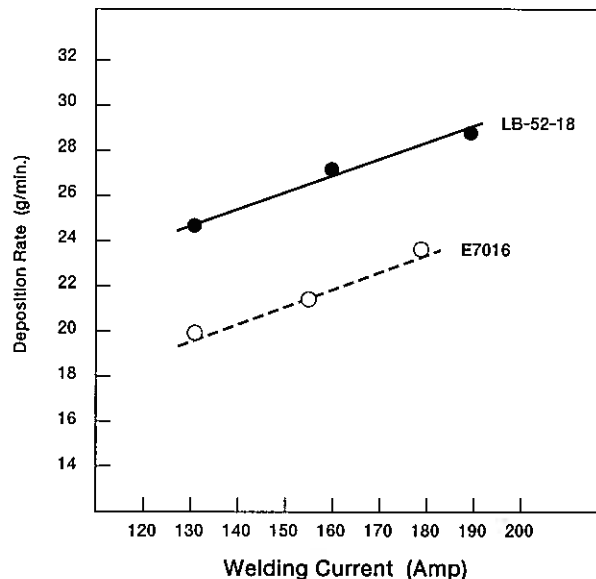

Fig.1 - A Comparison between LB-52-18 and an Ordinary E7016 Electrode on Deposition Rate



deposition rates when compared with the E7016 electrode.

The deposition rate is an important variable in welding economics. A higher deposition rate necessarily results in a faster speed or shorter time for welding a certain mass of groove. Shorter welding time can reduce labor costs. LB-52-18, therefore, can provide savings by up to 20% over ordinary E7016 electrodes when the costs for material and overhead are kept constant.

## Outstanding Features of LB-52-18

The features that help LB-52-18 stand apart from ordinary E7018 electrodes are:

- (1) Superior welding performance with either DC or AC currents. It is the Number 1 electrode among the various low hydrogen electrodes that use DC.
- (2) Superior mechanical properties: constant tensile strength and high impact value
- (3) Superior crack resistibility

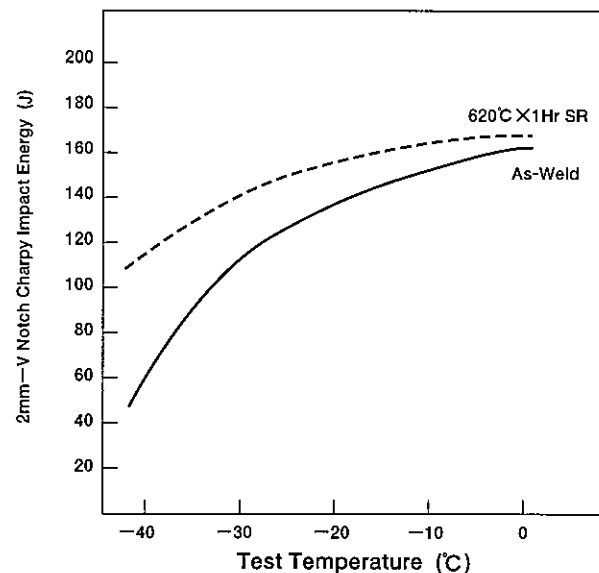

Fig.2 - Typical Impact Energy of LB-52-18 Deposited Metal

Fig. 2 shows the results of Charpy impact tests on LB-52-18 deposited metal using 2-mm-V-notch specimens at various testing temperatures. This high

impact strength makes LB-52-18 suitable for low-temperature applications down to -20°C, in addition to applications at room and elevated temperatures.

## Highly Reputed for 35 Years

Since it was launched, LB-52-18 has seen its features refined and its markets expanded. Kobe Steel pursues keen quality control in order to maintain the excellency of LB-52-18 produced in Japan and overseas. The maintenance of quality is an important factor in the high reputation LB-52-18 has persistently earned in such diverse fields as machinery, steel structures, bridge construction and shipbuilding.



Fig.3 - A High Deposition Rate of LB-52-18 is Valuable for the Maintenance Welding of Heavy-Duty Machinery in Crushing Plants

## How to Use LB-52-18

When higher welding speeds or shorter welding times are required, ordinary E7016 electrodes can be switched to LB-52-18 in any application. In particular, LB-52-18 really shines in all-position welding of pipes using DC power sources. You will get unsurpassed arc stability and a superior weld bead profile through the girth weld of the pipes, in addition to higher deposition rates. However, you cannot obtain these merits unless you follow some of the following precautions.

- (1) Re-dry LB-52-18 at 300 - 350°C for 30 - 60 minutes before use for every four-hour exposure to air without wetting unless otherwise specified. This is because the coating flux tends to pick up moisture in the air as shown in Fig. 4. Moisture can be a cause of spatters, porosity, irregular bead appearance and cold cracking. The moisture

content in the coating flux, therefore, should be maintained at 0.5% maximum by re-drying in order to prevent decreased usability and weldability.

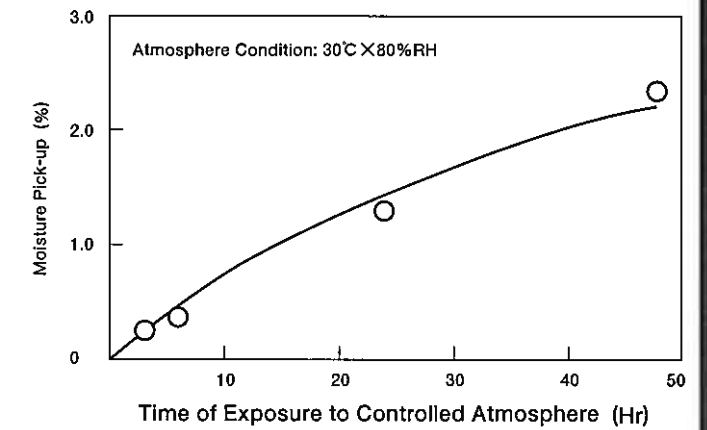

Fig.4 - The Relationship between Moisture Pick-Up and Time of Exposure to Controlled Atmosphere

- (2) Use the backstep technique at arc starting to prevent the occurrence of porosity at the starting area of the weld bead as illustrated in Fig. 5. This figure shows the backstep technique in the vertical-up position when welding a horizontally fixed pipe. This is a common practice for all low hydrogen electrodes.

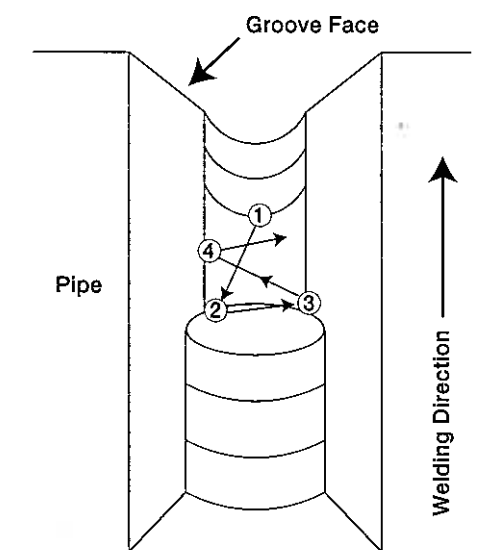

Fig.5 - The Backstep Technique in Vertical-Up Position Welding of Pipes  
 ① Arc Start  
 ② Backstep  
 ③ Following Step  
 ④ Following Step

# DW-308L

( AWS A5.22 E308LT0-1, E308LT0-4 )

DW-308L represents a new generation of stainless flux cored wires by significantly reducing spatter and fumes over a range of welding parameters while featuring self-peeling slag removal and glossy bead appearance.

## Basic Characteristics of DW-308L

As shown in the AWS classification designations above, DW-308L is suited for flat and horizontal position welding with both CO<sub>2</sub> gas and 75-80%Ar+CO<sub>2</sub> mixed gas shielding. DW-308L can be used in welding both 304L and 304 stainless steel.

## What Makes DW-308L a New Generation Wire?

Properly-controlled ferrite content (typically, 9% by Shaeffler Diagram) in DW-308L weld metal provides better resistibility to hot cracking. Additionally, low carbon content (typically, 0.027%) in DW-308L weld metal increases resistance to intergranular corrosion. The chemical composition of the weld metal provides superior mechanical properties and corrosion

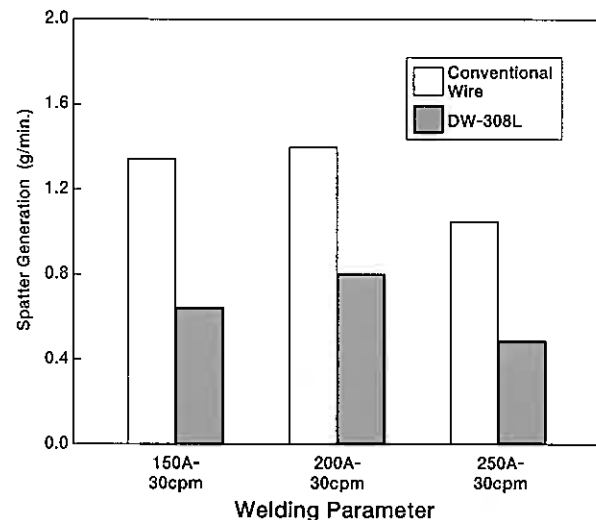

Fig.1 - A Comparison between DW-308L and a Conventional Flux Cored Wire on Spatter Generation (Wire Size: 1.2 mm φ, Shielding Gas: 100% CO<sub>2</sub>)

resistibility.

In addition to the sophisticated balance achieved in the chemical composition, DW-308L significantly lessens spatter and fumes. As shown in Fig.1, DW-308 reduces spatter by 40-50% over a range of welding parameters when compared to a conventional stainless flux cored wire. Materials savings can thus be realized in addition to savings in labor and material costs associated with postweld cleaning. As shown in Fig.2, DW-308L reduces fumes by 20-25% over a range of welding parameters when compared to a conventional stainless flux cored wire.

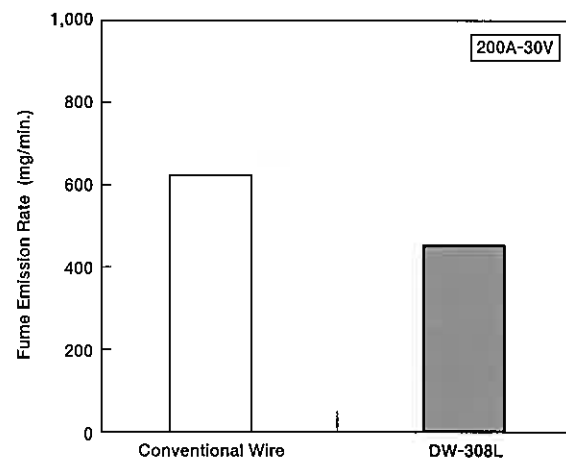

Fig.2 - A Comparison between DW-308L and a Conventional Flux Cored Wire on Fume Emission Rate (Wire Size: 1.2 mm φ, Shielding Gas: 100% CO<sub>2</sub>)

Convenient self-peeling slag removal and glossy bead appearance of DW-308L will leave you feeling very satisfied—Figs.3 and 4.

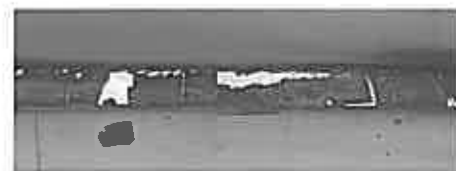

Fig.3 - Self-Peeling Slag Removal of DW-308L



Fig.4 - The Glossy Bead Appearance of DW-308L



# DW-308LP

( AWS A5.22 E308LT1-1, E308LT1-4 )

DW-308LP also represents a new generation of stainless flux cored wires, but in a different way than DW-308L. As easy to use as a mild-steel flux cored wire, DW-308LP can easily be used in all positions including vertical, horizontal, and overhead.

## Basic Characteristics of DW-308LP

As seen in the AWS classification designations shown above, DW-308LP is suitable for welding in all positions, with both CO<sub>2</sub> gas and 75-80%Ar+CO<sub>2</sub> mixed gas shielding. DW-308LP can be used in welding both 304L and 304 stainless steel.

## What Makes DW-308LP a New Generation Wire?

Like DW-308L, the sophisticated chemical composition of the weld metal in DW-308LP provides superior mechanical properties and corrosion resistibility. In addition, DW-308LP offers unsurpassed welding performance in all positions and over a range of welding parameters.

As shown in Fig.1, DW-308LP provides superior weld profiles with smooth fusion to the base metals and

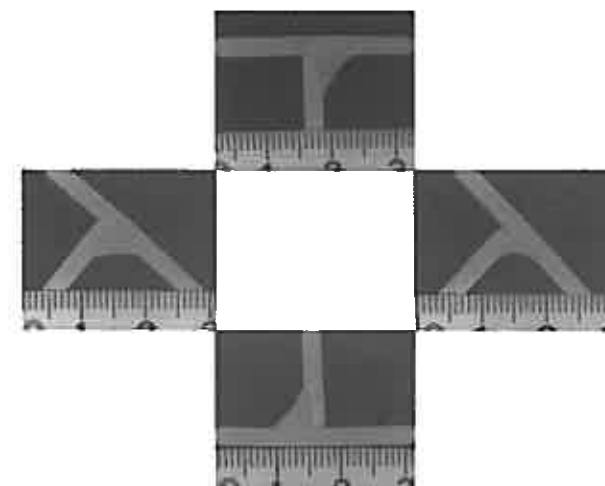

Fig.1 - Cross-Sectional Weld Profiles of DW-308LP (Wire Size: 1.2 mm φ) with SUS 304 Base Metal (Plate Thickness: 3 mm)

good penetration in such various welding positions as horizontal fillet, vertical-up, vertical-down and overhead.

It has generally been believed that welding stainless steel in vertical and overhead positions was more difficult than mild steel because molten metal was more likely to drop. This difficulty was assumed because of the differences in the physical properties of stainless steel: it has a lower melting point ( 1400-1427°C ) than mild steel ( 1500-1527°C ), and less thermal conductivity ( 0.04 cal/cm/sec/°C at 0-100°C as opposed to 0.11 cal/cm/sec/°C at 0-100°C ).

However, DW-308LP has jumped over these hurdles to become a superior flux cored wire suitable for welding in all positions. Fig.2 shows an example of an application for DW-308LP: a curved, large-diameter water pipe that, because of the inherent difficulty in positioning the work, requires all-position welding. DW-308LP is suitable for welding fixed pipes, storage tanks and rolling stock, which are all difficult to position during welding.



Fig.2 - A Water Pipe for the Water Gate Equipment under Fabrication by Using DW-308LP in All Positions

Finally, DW-308LP offers very good re-arc-starting, making it suitable for tack welding, automatic welding and robotic welding.

## What is Short Circuiting Transfer, and What is it Used for?

How molten metal is transferred in the arc, from the molten electrode tip to the weld pool, determines the manner of welding in various positions, the amount of spatter, and the quality of the welds. Based on studies using high-speed photography of MIG and MAG welding processes, the manner of molten metal transfer can largely be classified as:

- (1) globular transfer
- (2) spray transfer
- (3) short circuiting transfer

Both globular and spray transfer are also known as "free flight transfer," because the molten metals transfer while flying in the arc. Short circuiting transfer, however, is very different because the molten metals bridge the tip of the electrode and the molten pool in excess of 50 times per second during welding – Fig.1.

Short circuiting transfer enables the all-position welding, and features less spatter, shallower penetration, and less undercut than other manner of molten metal transfer.

Because of shallower penetration, short circuiting transfer is often used for welding sheet metals in particular, in auto, rolling stock and electrical appliance industries.

The character of the molten metal transfer is largely dependent on the composition of the shielding gas, the alloy composition of the electrode (welding wire) and the electrical parameters (welding amperage and voltage). Among Kobe Steel's varieties of MIG and MAG welding wires, some wires are designed for short circuiting transfer welding. They offer better arc stability at lower currents for stable short circuiting transfer. Examples include MG-51T (AWS A5.18 E70S-6), and MX-100T (AWS A5.20 E71T-1, E71T-1M) for mild steel and 490N/mm<sup>2</sup> high tensile steel.

## A Small Country, a Big Coverage by AMD

Greetings from the sunny island of Singapore! In today's markets, a major topic in business is the regional financial crisis that has affected every ASEAN country's economic growth. Singapore is one of the more fortunate countries in the region having escaped the brunt of the Asian currency crisis. However, while recent projections on our country's economic growth stand at 2.5 to 4.5 per cent, the private sector forecasts that it may slip to 1.5 per cent for the full year. The economy's dependence on providing financial services to the region means that as the growth in the neighbouring countries slows, Singapore will follow suit. The question now is "Will Singapore slide into a recession this year?" since there are so many uncertainties regarding the ultimate depth of recession in other countries and the contraction in export demands.

The ASEAN Marketing Department (AMD) of Kobe Welding Singapore (KWS) was established by Kobe Steel (KSL) in 1989 as the marketing arm of KWS and other KSL ASEAN regional production bases, providing technical services, throughout Southeast Asia as well as Singapore. There are currently four technical personnel – from Malaysia, Singapore, India and Japan – who are managed by the department manager in AMD, and who have the responsibility to handle all kinds of welding technical inquiries. AMD also provides training for sales personnel in all regional distribution sources. The department also assists and cooperates in market planning, conducting marketing surveys, and establishing marketing strategies and tactics.

The markets covered by AMD are not restricted to the ASEAN countries, as the technical personnel of AMD have been servicing customers in such countries as Australia, New Zealand, Hong Kong, Taiwan, India, Pakistan, The People's Republic of China and the Middle East.

For the local market in Singapore, AMD supports the three major distributors in servicing and marketing both KWS and KSL welding consumables. AMD personnel often visit customers with the local distributors as it



Technical Assistance for an End User at Site in Malaysia (Above)

AMD Personnel at the Operation Department (Above)

often said, "One spoken phrase from AMD is better than 10 spoken phrases of a sales representative." This is because the customers have more confidence and trust with the decisions and recommendations of AMD personnel since they believe that we know our products best. The high technical competency level of AMD is supported by experienced Japanese welding engineers and technical backup from the Technical Department of Kobe Steel, Japan.

AMD personnel sometimes organize cohesive programmes for major customers. These programmes include plant visits, bowling competitions, golf games, dining out with local distributors and agents, invitations to technical seminars, overseas incentive trips to KSL Japan, and AOTS regional courses. And with these cohesive programmes, we are able to establish and maintain good working relationships with many key personnel of such major companies as Keppel Shipyard, FELS, Sembawang Shipyard, Jurong Shipyard, Hitachi Zosen S'pore, just to name a few.

With the current sluggish market situation, AMD will do its best to maintain all the activities mentioned above. All these years, AMD has maintained its reputation by providing technical backup and customer services within 48 hours of a request. While many of our competitors have offered similar technical services, they never mention how long it would take. So we would like to suggest our readers: Why not give us this challenge? Call us any time!

(Reported by Mr. Alex Ong, KWS)

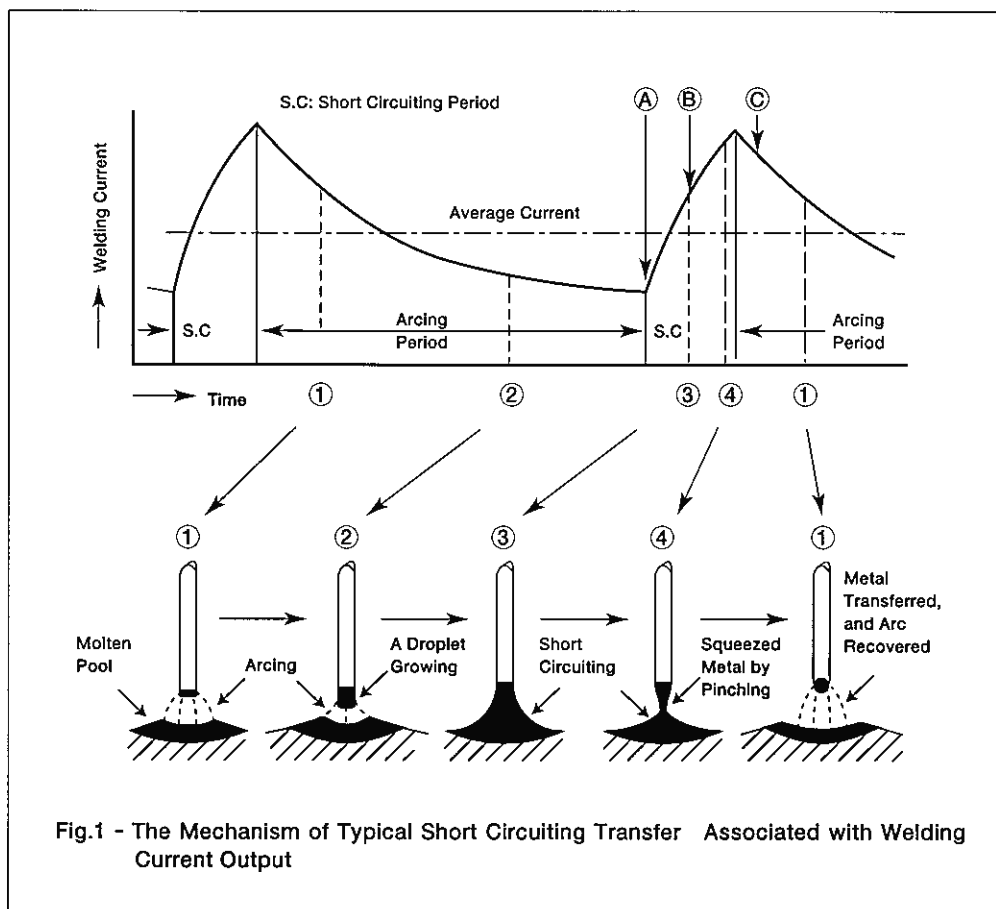

Fig.1 - The Mechanism of Typical Short Circuiting Transfer Associated with Welding Current Output

## Japan International Welding Show '98 Attracts 90,000 Visitors



A Part of Kobe Steel's Booth (Above)



Welding Demonstration (Above)



From Left at the Reception: Ms. Naksuban(KMWT)  
Ms. Post(KWE) Ms. Park(KWK) Ms. Toh(KWS) (Above)

The Japan International Welding Show '98 was held at the Tokyo Big Site exhibition hall from April 8th through the 11th. 167 corporate exhibitors, including 75 foreign companies from 17 countries, attended. 91,511 visitors, including 1,879 foreigners, visited the exhibition. Kobe Steel exhibited welding consumables and equipment with four concepts: "a goal for better welding amenity," "a goal for higher quality," "a goal for higher welding efficiency," and "a goal for the future." A new slogan was also launched: "If You Notice, Kobelco Is There, Now, Old Days, and Future." The wide range of welding consumables exhibited included the less-fume-and-less-spatter flux cored wires, the high-welding-efficiency products and some new products. In particular, eight new products reflected

Kobe Steel's superiority in technical development. The goal for the future, reflecting hopeful possibilities, drew the attention of many visitors. We, Kobe Steel, are proud of our performance as one of the top ranking companies in the welding field.

In addition, in light of Kobe Steel's policy of globalization, some women employees from several of the Kobelco Welding Group's subsidiaries participated and played an important role in communicating with foreign visitors at Kobe Steel's booth. During the welding demonstrations, a large crowd of people rushed to Kobe Steel's booth, which created a pleasant international mood. The next welding show will be held in April, 2000, in Osaka.

## Kobelco Flux Cored Wires Shine in the '98 AWS Welding & Fabrication Exposition, Detroit



KWAI's Booth Popular to International Visitors (Above)

The '98 AWS Welding & Fabrication Exposition was held at the Cobo-Hall exhibition site in Detroit from the 28th through the 30th of April. The number of exhibitors totaled 650 companies, and there were an estimated 25,000 visitors. The city of Detroit is famous as the city of cars and steel materials, so it was the best

location for the welding show. Kobelco Welding of America (KWAI) attended as an exhibitor – making its ninth appearance in an American welding show – and conducted a PR campaign focusing on flux cored wires. Stainless and mild steel flux cored wires, which are popular in the US market, were exhibited and demonstrated with a special focus on:

- DW-316L (E316LT0-1, -4)
- DW-309MoL (E309LMoT0-1, -4)
- DW-2209 (E2209T0-1, -4)
- FRONTIARC-711 (E71T-1, -1M, -12, -12M)
- DWA-50 (E71T-1M)
- DWA-55ESR (E71T-12MJ)
- MX-200 (E70T-1)

Many visitors from the US and overseas came to KWAI's booth, and were very interested in talks with us. Detroit has since handed over the baton to St. Louis for the next welding show.

## Beijing-Essen Welding '98 Appeals to the World



KSL's Booth Popular to Many Visitors (Above)

Welding Demonstration (Right)

The Beijing-Essen Welding '98 exhibition was held at the Chinese International Exhibition Center in Beijing during the 26th through the 30 of May. Kobe Steel exhibited and demonstrated several products putting special emphasis on flux cored wires. It was a welding show that reflected the feelings of hope and opportunity from Asia to the rest of the world. Many

visitors called at KSL's booth. 224 corporate exhibitors attended, and about 25,000 visitors visited the exhibition from all over the world.

Technical seminars were held at the site during the fair. Kobe Steel dispatched the researcher, Mr. Takeshi Nakagawa. He made a lecture for the general audience regarding "Welding for Boilers and Reactors". He explained the character of Cr-Mo welding material. More than 40 people gathered and listened to the lecture earnestly.



Technical Seminar by Kobe Steel (Above)

## Kobe Welding of Korea is Awarded by the Korean Government

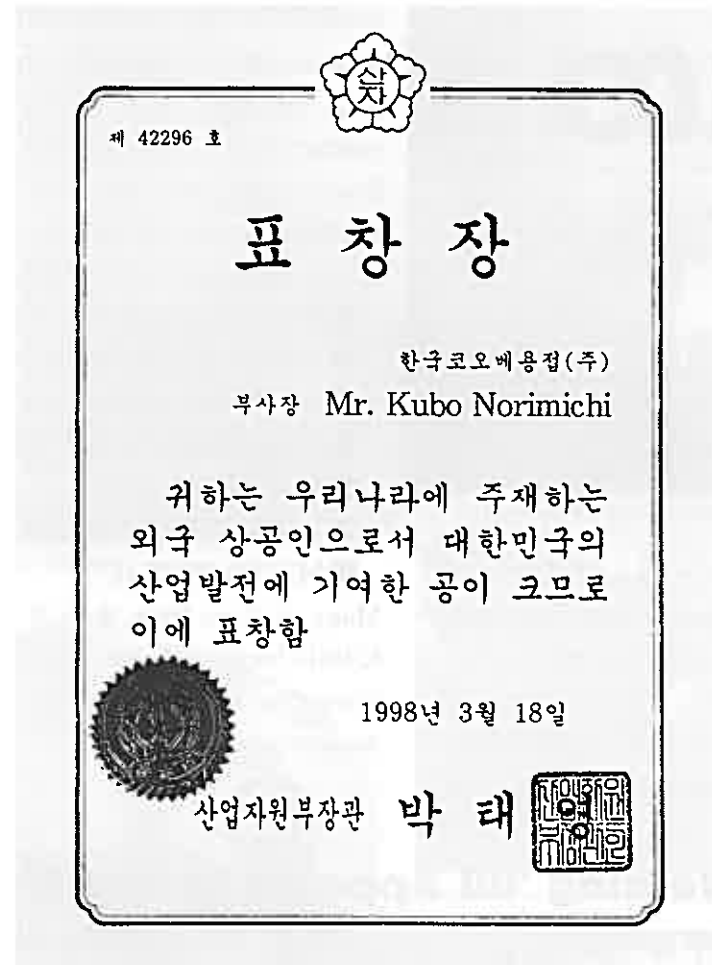

The Prize of the Chief of the Industrial Resources Department (Above)

On the 18th of March, the 25th ceremony commemorating "The Day of Trade and Industry" was held at the Education and Culture Theater in Seoul. On this occasion, Kobe Welding of Korea (KWK) was awarded a prize by the Chief of the Industrial Resources Department for excellence in the field of Foreign Trade and Industry Representatives to Korea. Norimichi Kubo, the vice president of KWK, represented KWK at the ceremony. At the reception afterwards, Kim Jong-pil, the prime minister of Korea, Park Tae Young, the chief of the Industrial Resources Department, Jung Mung Gyu, the chairman of the Hyundai Group, and other Koreans of great political and business influence attended.

With the production of high quality flux cored wires, KWK, established in 1995, has contributed to earning foreign currencies in the promotion of exports from Korea and to the development of Korean industries. This is why KWK was awarded the prize. Prior to receiving

this prize, KWK, through the effort of all its employees, was awarded the Prize of One-Million-Dollar Exports in 1996 and the Prize of Five-Million-Dollar Exports in 1997. After receiving the prize, Mr. Kubo told, "On behalf of KWK, a young company only three years old, I am very much grateful of being awarded this honorable prize. This reward is thanks to our customers of the Korean shipbuilding industries in particular who have relied on and used KWK's products.... KWK earned the ISO 9002 certificate in March. With high quality products, we, KWK, will try to contribute to the development of Korean industries."



The ISO 9002 Certificate KWK Earned with Reliable, High Quality Products (Above)

### <Translation>

You are honored as a foreign company stationed in Korea for contribution to the development of Korean industries.

## LB-52U stands up in Neftegaz Oil & Gas Fair '98, Moscow



Neftegaz Oil & Gas Fair '98 was held at ZAO Expocentr's Kransnaya Presnya Fairgrounds in Moscow during the 22nd through the 26th of June. Kobe Steel exhibited LB-52U(E7016)mainly. LB-52U is a low hydrogen type covered electrode for exclusive use for one-side welding of pipes and general structures. In fact, LB-52U has been used for welding pipes of more than 30,000 tons in Russia. For its sure quality many visitors called at KSL's booth, and were very interested in discussion with us.

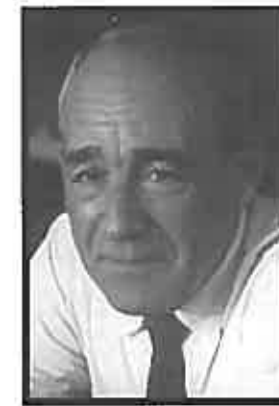

Mr. Maurice Jourden of Contimine S.A. Belgium passed away on April 16th, 1998, at the age of 72.

He was very loyal to Kobe Steel over many years, and helped to establish Kobe Steel welding consumables by first introducing them to European shipbuilders more than 30 years ago.

His friendly character endeared him to customers and colleagues alike. We at Kobe Steel honor his life-time service and mourn his passing.

### Editorial Postscript

In this issue, we have added a new column, called "The ABCs of Arc Welding." We will continue to include this new column, which focuses on fundamental technical knowledge of arc welding in every issue. We will be pleased, if this column will help you know about welding processes, welding consumables, welding

fabrication, and inspection even in a minor way.

We are looking forward to any frank messages from the readers about this bulletin. Please contact a Kobelco office most convenient to you.

## KOBELCO WELDING TODAY

July 1998, Vol.1 (No.3)

Publisher : The International Operations Dept., Welding Div., Kobe Steel, Ltd.

Printer : Fukuda Printing Co., Ltd.

Editor : KOBELCO WELDING TODAY Editorial Staff

URL : <http://www.kobelco.co.jp>



WELDING CONSUMABLE

# KOBELCO

THE WORLDWIDE MANUFACTURER

## GLOBAL MANUFACTURING AND SALES BASES

**JAPAN :**  
KOBELCO WELDING OF JAPAN LTD. Welding Division  
International Operations Dept.  
KOBELCO Bldg. 3-27pyo 2-chome, Koto-ku, Tokyo 135-8381  
JAPAN  
Tel. (81)3 5634-5031 Fax. (81)3 5634-5047

**EUROPE :**  
KOBELCO WELDING OF EUROPE B.V.  
Eisterweg 8, 6422 PN, Heerlen, The Netherlands  
Tel. (31)45-547-1111 Fax. (31)45-547-1100

**USA :**  
KOBELCO WELDING OF AMERICA INC.  
7478 Harwin Drive, Houston, Texas 77036, USA  
Tel. (1)713 974-5774 Fax. (1)713 974-6543

**KOREA :**  
KOBELCO WELDING OF KOREA CO., LTD.  
21-14, Palryong-Dong, Changwon, Kyongnam, Republic of  
Korea  
Tel. (82)551 92-6886 Fax. (82)551 92-7786

**SINGAPORE :**  
KOBELCO WELDING (SINGAPORE) PTE. LTD.  
20, Pandan Avenue, Jurong, Singapore 609387, Republic of  
Singapore  
Tel. (65)2 68 27 11 Fax. (65)2 64 17 51

**THAILAND :**  
THAI-KOBELCO WELDING CO., LTD.  
500, Soi 1, Bangpoo Industrial Estate, Sukhumvit Road,  
Praeksa, Samutprakarn 10280, Thailand  
Tel. (66)2 324-05 88 91 Fax. (66)2 324-07 97

**KOBELCO WIRE (THAILAND) CO., LTD.**  
491, Soi 1, Bangpoo Industrial Estate, Sukhumvit Road,  
Praeksa Samutprakarn 10280, Thailand  
Tel. (66)2 324-05 88 91 Fax. (66)2 324-07 97

**MALAYSIA :**  
ST KOBELCO WELDING (MALAYSIA) SDN. BHD.  
Plot 502, Jalan Perusahaan Baru, Kawasan Perusahaan  
Prai, 13600 Prai, Malaysia  
Tel. (60)4-3905792 Fax. (60)4-3905827

**INDONESIA :**  
P.T. INTAN PERTIWI INDUSTRI  
(Technically-Collaborated Company)  
Jalan P Jayakarta 45, Block A/27,  
Jakarta 11110, Indonesia  
Tel. (62)21-639-2608 Fax. (62)21-649-6081

**PHILIPPINES :**  
WELDING RESOURCES INTERNATIONAL INC.  
(INDUSTRIAL WELDING CORPORATION)  
(Technically-Collaborated Company)  
No. 10, R. Jacinto Street, Canumay, Valenzuela, Metro Manila,  
1440, Philippines  
Tel. (63)2-292-6968 Fax. (63)2-292-6974

INTERNATIONAL SLOGAN KOBELCO WELDING GROUP

# QTQ

**Quality Products    Technical Support    Quick Delivery**